

TEKOM

Savunma ve Havacılık Sanayi A.Ş.

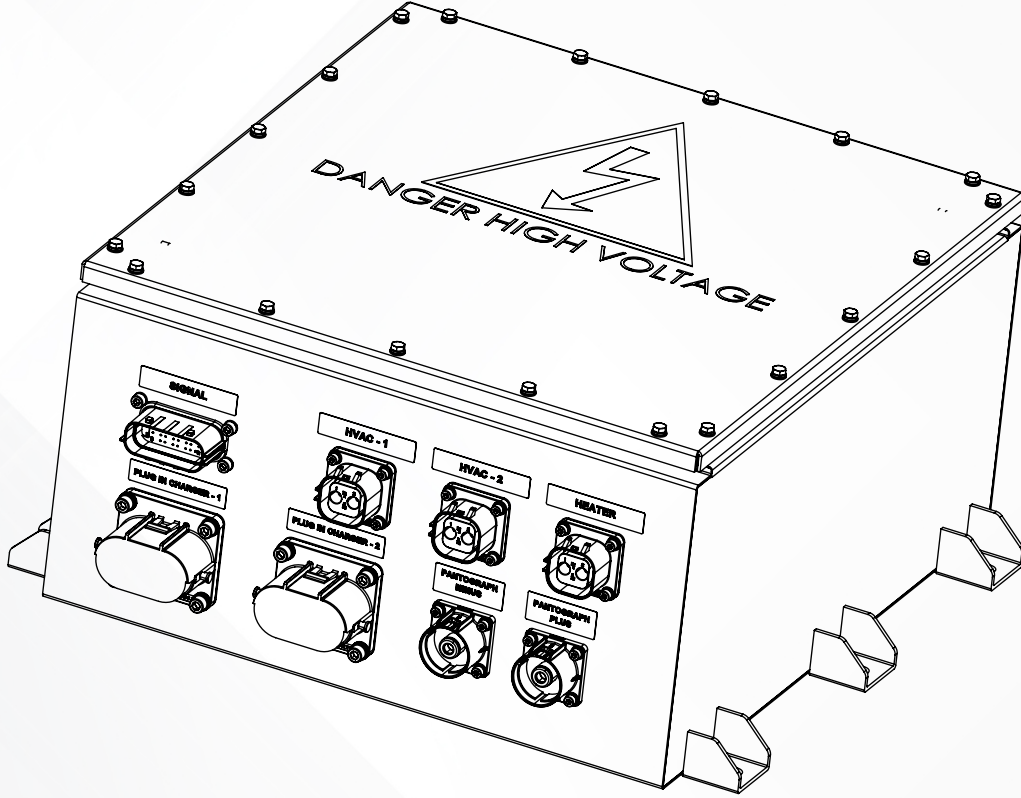

GÜÇ DAĞITIM ÜNİTELERİ
POWER DISTRIBUTION UNITS

12m OTOBÜS PDU

P/N: 01-8200121

12m BUS PDU

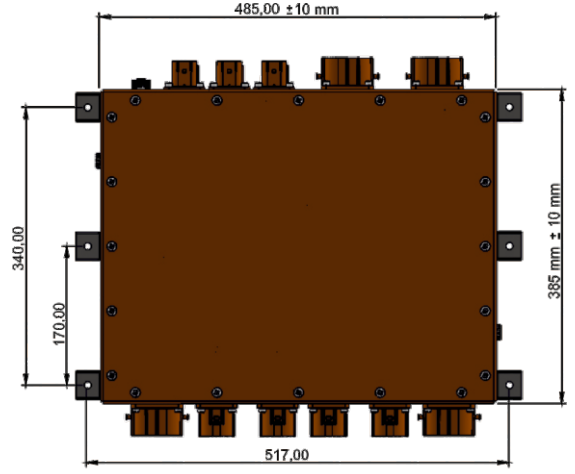

TEKNİK ÖZELLİKLER / TECHNICAL SPECIFICATIONS

- Gövde Malzeme: Çelik (St37) / Body Material: Steel (St37)

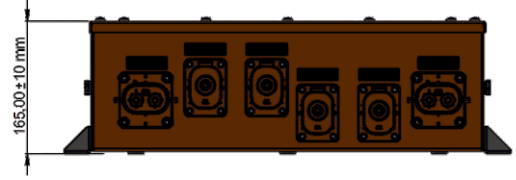

ZIRHLI ARAÇ PDU

P/N: 01-8200222

ARMORED VEHICLE PDU

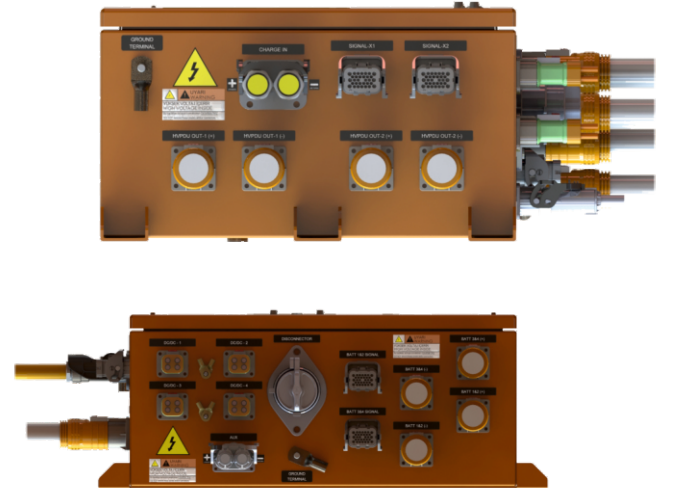

TEKNİK ÖZELLİKLER / TECHNICAL SPECIFICATIONS

- Gövde Malzeme: Çelik (St37) / Body Material: Steel (St37)



18m OTOBÜS PDU

P/N: 01-8200422

18m BUS PDU

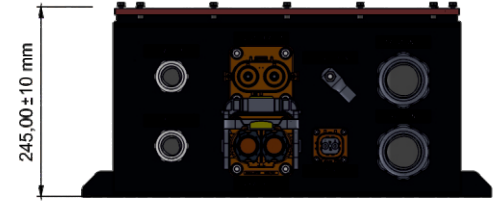
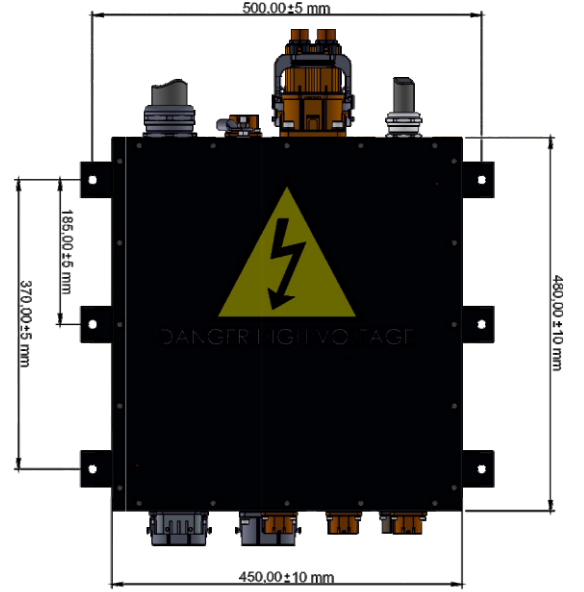

TEKNİK ÖZELLİKLER / TECHNICAL SPECIFICATIONS

- Gövde Malzeme: Çelik (St37) / Body Material: Steel (St37)

e-MDX MINIBÜS PDU

P/N: 01-8200522

e-MDX MINIBUS PDU

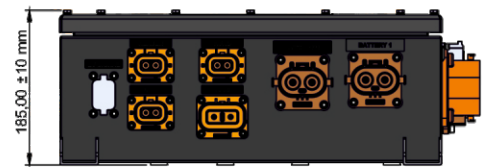
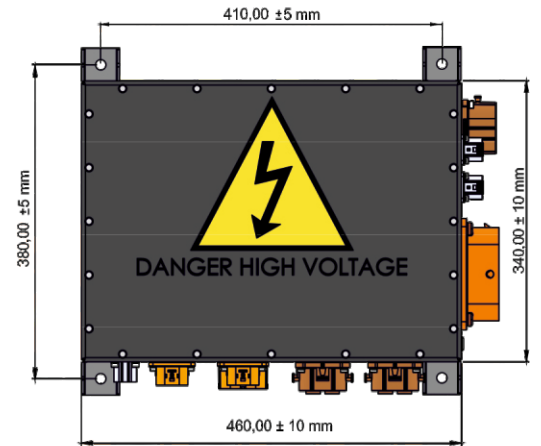

TEKNİK ÖZELLİKLER / TECHNICAL SPECIFICATIONS

- Gövde Malzeme: Çelik (St37) / Body Material: Steel (St37)



ZIRHLI ARAÇ JB

P/N: 01-8200322

ARMORED VEHICLE JB



TEKNİK ÖZELLİKLER / TECHNICAL SPECIFICATIONS

- Gövde Malzeme: Çelik (St37) / Body Material: Steel (St37)

BATARYALI GÜÇ KAYNAĞI

P/N: 02-0903722

BATTERY POWER SUPPLY



TEKNİK ÖZELLİKLER / TECHNICAL SPECIFICATIONS

- Çalışma Gerilimi / Operating Voltage

Giriş : 9-32 VDC / Çıkış : 24 VDC / Input : 9-32 VDC / Output : 24 VDC

- Gövde Malzeme: Alüminyum (5083) / Body Material: Aluminum (5083)

GÖVDE SİGORTA KUTUSU-M52 OBÜS

NSN: 6110-27-025-7776

FUSE BOX



YARDIMCI KONTROL ÜNİTESİ-FIRTINA OBÜS

AUXILIARY CONTROL UNIT

P/N : TK-02-0901107
NSN: 2540-27-018-6470



KULE GÜÇ DAĞITIM ÜNİTESİ-FIRTINA OBÜS

TURRET POWER DISTRIBUTION UNIT

P/N : TK-01-8100707
NSN: 6110-27-018-7142



MERMİ DOLDURMA KONTROL PANELİ-FIRTINA OBÜS

BULLET LOADING CONTROL UNIT

P/N : TK-02-0901211
NSN: 5895-27-018-6602



GÜÇ DAĞITIM KUTUSU-LEOPARD 1

POWER DISTRIBUTION BOX

NSN: 2590-12-155-8069



PULAT KONTROL PANELİ

PULAT CONTROL UNIT

P/N : TK-01-8101218



ATEŞLEME ANAHTAR KUTUSU-FIRTINA OBÜS

FIRING SWITCH BOX

P/N : TK-02-0900510

NSN: 5930-27-018-6829



KONNEKTÖR ÇÖZÜMLERİMİZ AVAILABLE CONNECTOR SOLUTIONS

AMPHENOL



RENHOTEC



TE CONNECTIVITY



ANNREN



SİGORTA ÇÖZÜMLERİMİZ AVAILABLE FUSING SOLUTIONS

SINOFUSE

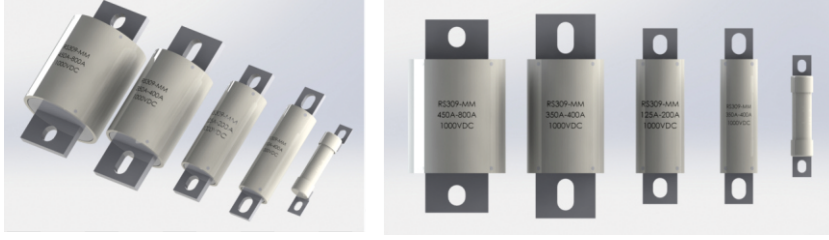

MERSEN



ADLER



YÜKSEK GERİLİM KONTAKTÖR ÇÖZÜMLERİMİZ HIGH VOLTAGE CONTACTOR SOLUTIONS

GIGAVAC



KILOVAC



GLVAC



ELEKTRONİK KART ÇÖZÜMLERİMİZ HIGH VOLTAGE MEASUREMENT SOLUTIONS

ISABELLENHÜTTE

AKIM ve GERİLİM
CURRENT and VOLTAGE



SENDYNE

AKIM ve GERİLİM
CURRENT and VOLTAGE



BENDER

İZOLASYON ÖLÇÜMÜ
ISOLATION MONITOR



TASARIMLARIMIZ OUR DESIGNS

YÜKSEK GERİLİM KONTROL ÜNİTESİ EV HIGH VOLTAGE CONTROL UNIT

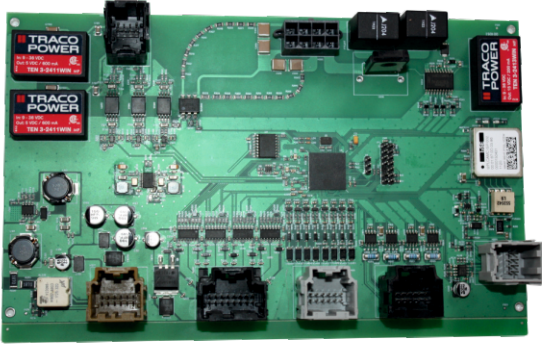

XY-EMI FİLTRE KARTI EV XY-EMI FILTER CARD

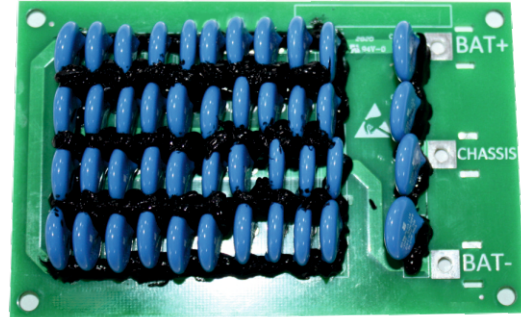

BATARYA KONTROL ÜNİTESİ EV BATTERY CONTROL UNIT

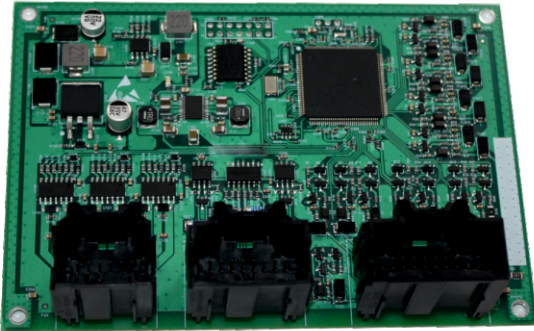

BATARYA YÖNETİM SİSTEMİ EV BATTERY MANAGEMENT SYSTEM

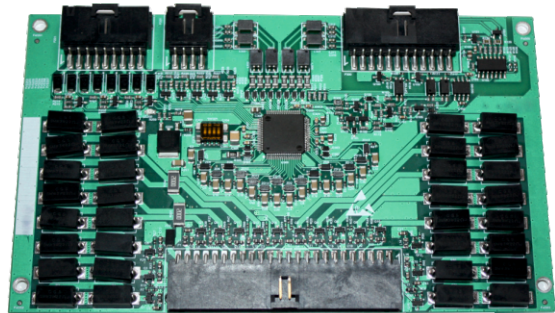



Certificate of Registration

This certificate has been awarded to

TEKOM SAVUNMA VE HAVACILIK SAN. A.Ş.
Ertuğrul Gazi Mah. Doğanlar Sok. No:27/A Kartepe KOCAELİ, Türkiye

in recognition of the organization's Quality Management System which complies with

ISO 9001:2015

The scope of activities covered by this certificate is defined below

Design, Production, Sales, Import and Export of Electrical, Electronic, Electromechanical, Control Systems and Lighting Systems of Defense Industry, Aviation and Automotive Spare Parts Produced in its Own Facility

Certificate Number 211017/A/0001/UK/En			
Date of Issue of Certification Cycle	Issue Number	Certificate Expiry Date	Certification Cycle
10 June 2024	1	08 June 2026	1
Revision Date	Revision Number	Original Certificate Issue Date	Scheme Number
10 June 2024	1	09 June 2023	n/a

For detailed explanation for the data fields above, refer to <http://www.urs-holdings.com/logos-and-regulations>



Certificate of Registration

This certificate has been awarded to

TEKOM SAVUNMA VE HAVACILIK SAN. A.Ş.
(Central Function) Ertuğrul Gazi Mah. Doğanlar Sok. No:27/A Kartepe KOCAELİ, Türkiye

In recognition of the Organization's Quality Management System which Complies with and has been Audited in Accordance with the Aerospace Sector Certification Scheme EN9104-001:2013 and Meeting the Requirements of ISO 9001:2015 and the Relevant AS Scheme Documentation as Defined below, for the Activities Described in the Scope of this Certificate (URS is Accredited under the control of the ICOP Scheme) which complies with

AS 9100D & ISO 9001:2015

The scope of activities covered by this certificate is defined below

Design and Manufacturing of Interior and Exterior Led Lighting Systems, Switches, Temperature Sensors and Pressure Sensors (Multi-Site)

Certificate Number 211017/B/0001/UK/En			
Date of Issue of Certification Cycle	Issue Number	Certificate Expiry Date	Certification Cycle
27 July 2023	1	26 July 2026	1
Revision Date	Revision Number	Original Certificate Issue Date	Scheme Number
08 August 2024	3	27 July 2023	n/a

For detailed explanation for the data fields above, refer to <http://www.urs-holdings.com/logos-and-regulations>

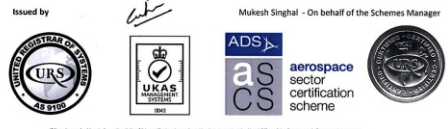

NOTLAR

NOTES

TEKOM

Savunma ve Havacılık Sanayi A.Ş.



Ertuğrul Gazi Mh. Doğanlar Sk. No:27/A
Kartepe- Kocaeli / TURKEY



+90 262 371 53 13 - 14



+90 262 371 18 28



info@tekom.com.tr



tekomsavunmahavacilik



www.tekom.com.tr